

Yealink CM50 Datasheet

Yealink CM50 is an innovative Dante ceiling microphone system that utilizes beamforming voice pickup technology. With 127 microphone units, it effortlessly covers a 5-meter radius pickup range and supports 8 independent customizable pickup areas. CM50 features prioritized pickup and acoustic fence functions to accurately capture sound within customized areas, effectively reducing unwanted environmental noise interference.

Equipped with AI-based sound optimization technology, CM50 intelligently eliminates noise and reverberation, ensuring a true and immersive auditory experience. With AI-driven dynamic feedback suppression and highly directional pickup beams, CM50 optimizes and simplifies deployment. It also supports the Dante AES67 protocol, offering expandability for the CM50 system. With unparalleled audio fidelity and intelligent sound optimization, Yealink CM50 provides an unmatched experience for meetings and events.



Features



Dante Microphone



127 Microphone Units



5-meter Radius High-Quality Pickup



8 Custom Pickup Areas



AI-Based Sound Optimization



Intelligent Design



Acoustic Adaptation



Sound Source Localization



AI Feedback Suppression



Yealink Room Designer

The Yealink CM50 has a 5 m radius premium, the default coverage area is 10 m by 10 m dynamic coverage area (STIPA > 0.76)

- Reverberation Level RT60 = 408 ms @ 1 kHz
- Room noise level (weighted) = 40 dB(A) SPL (according to IEC 60268-16)

Ultra Coverage, High Fidelity

Yealink CM50 microphone features 127 omnidirectional pickup units and beamforming technology for fast and accurate sound capture. It supports up to 8 customizable pickup zones, reducing noise and delivering pure sound. Experience enhanced convenience and exceptional audio in complex meeting spaces with CM50!

AI Voice Optimization

Yealink's AI sound optimization model, trained in-house, combines intelligent noise reduction and echo cancellation algorithms for an exceptional audio experience. Yealink's AI sound optimization algorithm eliminates background noise and minimizes the impact of echo, ensuring your voice remains clear and sharp.

Intelligent Design and Deployment

Yealink's exclusive intelligent design and deployment feature, coupled with Room Designer software, offers a complete meeting room design experience with just basic room data. Yealink's acoustic environment adaptation solution provides algorithmic customization and tuning based on the room's acoustic environment, reducing deployment costs and improving efficiency. Achieve efficient and precise audio solution deployment with Yealink!

Deep Integration with Microsoft Teams

Deeply integrated with Microsoft Teams, Yealink offers convenient features like automatic EQ switching and mute synchronization. Precise CM50 sound source localization ensures accurate camera tracking, making Yealink the best choice for your AV meetings. Combined with Yealink's native Teams room solution MVC, the CM50 solution provides an all-in-one, full Dante audio experience.

Easy deployment

Yealink CM50 requires only one PoE+ cable for power and data transmission. We offer the quickest deployment solution by directly replacing ceiling tiles, eliminating the need for drilling. It fits mainstream ceiling sizes of 60 *

60cm or 2 * 2ft. Optional accessories for suspension or adhesive ceiling mounting are included in the package.

Widely Compatible Conference Audio Solution

The CM50 works seamlessly with standard Dante/AES67 audio processors, such as Q-SYS Core series, enabling smooth integration with video conferencing hardware that connects via Dante, AES67, USB, or analog interfaces—such as systems running Microsoft Teams, Cisco Webex, or Zoom. By being fully tested with a wide range of video conferencing systems, it delivers stable connectivity and high-quality conferencing experiences across enterprise-grade environments, making it ideal for modern hybrid workspaces.

Hardware Deployment

In the Ceiling

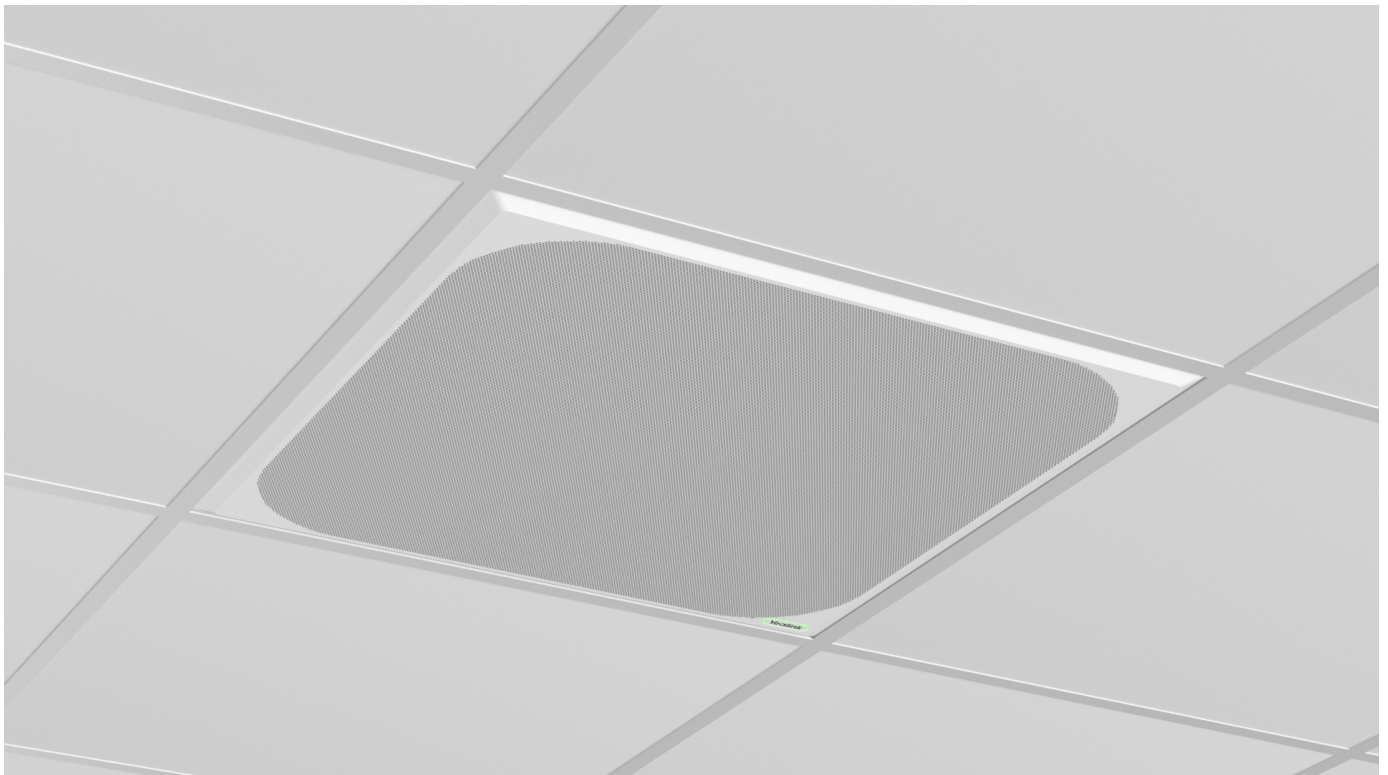

Suspend from the Ceiling

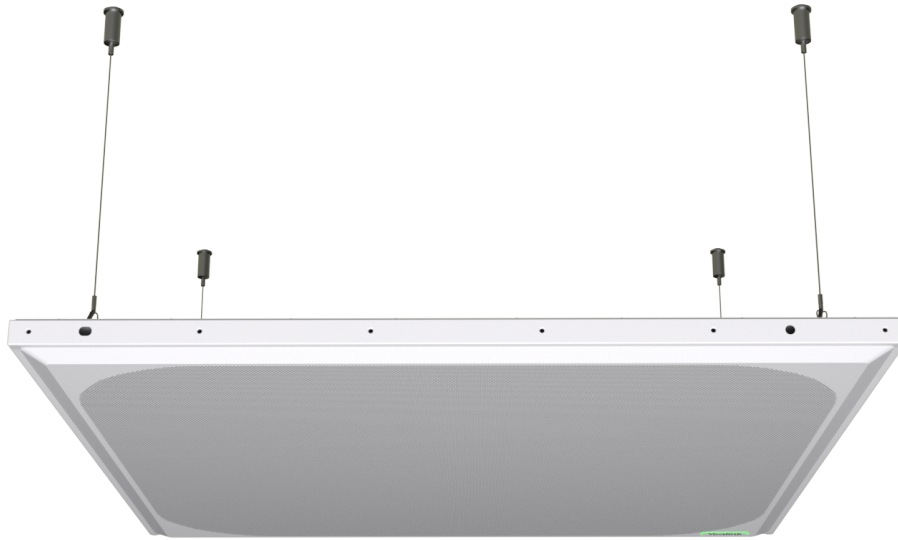

On the Ceiling

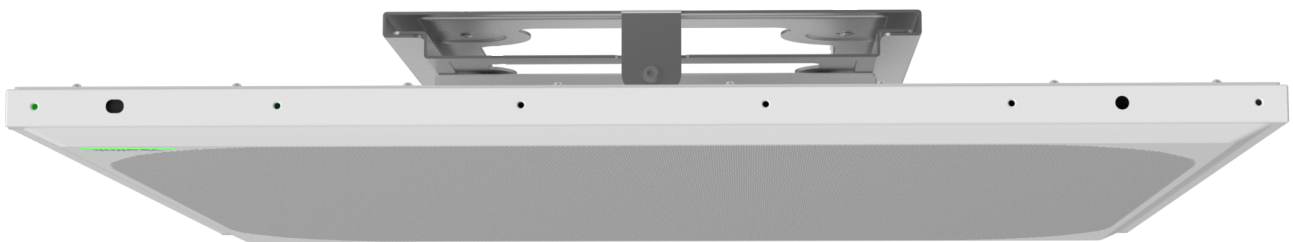

Specifications

Parameters	Description
------------	-------------

Acoustic Parameters	<ul style="list-style-type: none"> • Frequency response range: 120-20KHz • Sensitivity: 0 dBV/Pa 94dB SPL@1kHz • Signal-to-noise ratio: 86dB @1kHz, 94dB SPL A-Weighted • Maximum sound pressure level: 122dB at < 1% THD • Dynamic range: 86dB @<1% THD • Support Protocol: Dante, AES67
Dante Audio	<ul style="list-style-type: none"> • Output channels: 8+2 Dante output channels • Input channels: 2 Dante input channels • - 1 Dante input for AEC reference • - 1 Dante input for AFC reference • Sampling rate: 48K • Bit depth: 24-bit
Encryption Solutions	<ul style="list-style-type: none"> • Dante Media Encryption with AES-256 encryption (Works with Dante Brooklyn 3, Dante IP Core and Dante Pro S1) • Yealink Audio Encryption with AES-256 encryption (Works with Yealink AVBridge)
Product Design	<ul style="list-style-type: none"> • Microphone array: 127 MEMS array • Acoustic technology: Beamforming • Product dimensions: L592*W592*T56 mm • Product weight: 5.15 kg (net weight, excluding accessories) • Product color: Apple White • Product Material: SGCC/SPCC/AL5052 • Certification: Plenum Rated UL 2043 (suitable for air handling spaces) • Physical interface: <ul style="list-style-type: none"> • - 1* RJ-45 interface • - 1* 3-pin Phoenix connectors for analog output
Operating Information	<ul style="list-style-type: none"> • Power requirements: IEEE PoE+ (IEEE 802.3at class 4) • Power consumption: <ul style="list-style-type: none"> ◦ Rated power: 19.3 W ◦ Typical power: 17 W • Operating temperature: 0-40°C • Operating humidity: 0-93%RH
Logistics Information	<ul style="list-style-type: none"> • Giftbox dimensions (L*W*H): 722*687*110 mm • Weight: <ul style="list-style-type: none"> • - N.W/CTN: 7.750 kg • - G.W/CTN: 9.790 kg • Storage temperature: -30~70°C

Frequency Response Curve

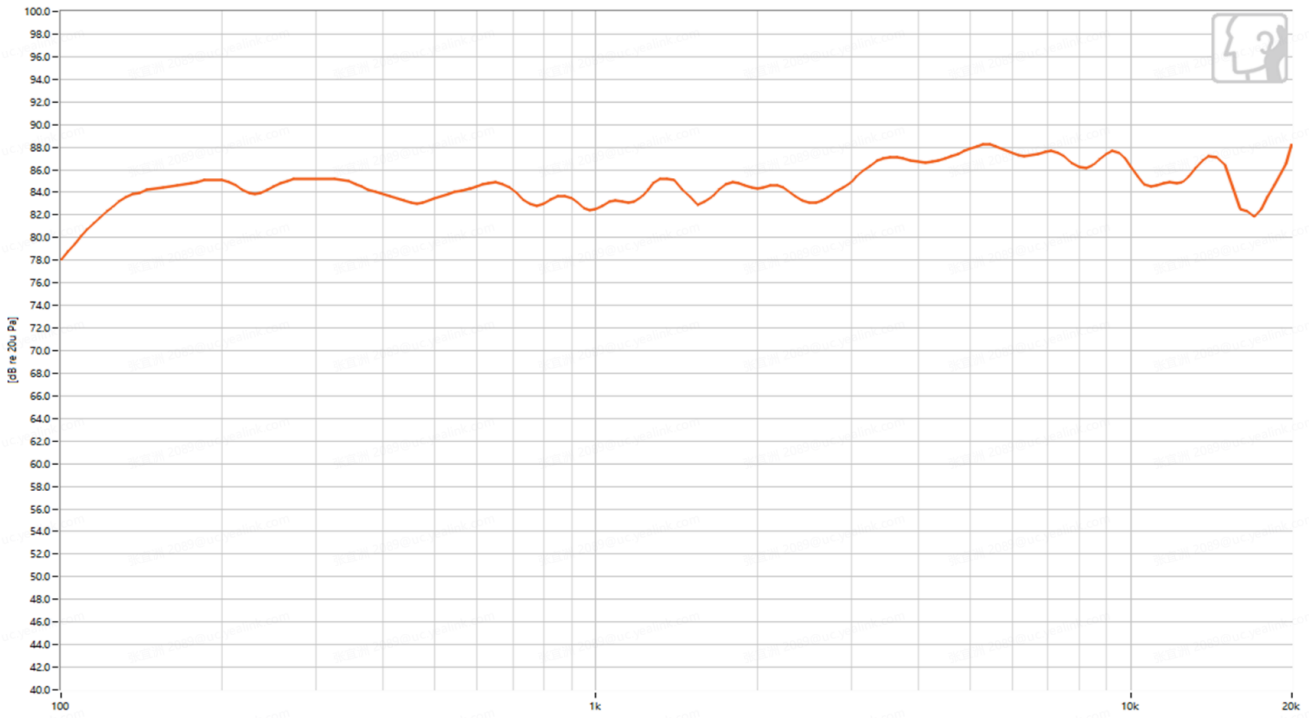

Polarity Diagram

The shape of the lobe is: medium

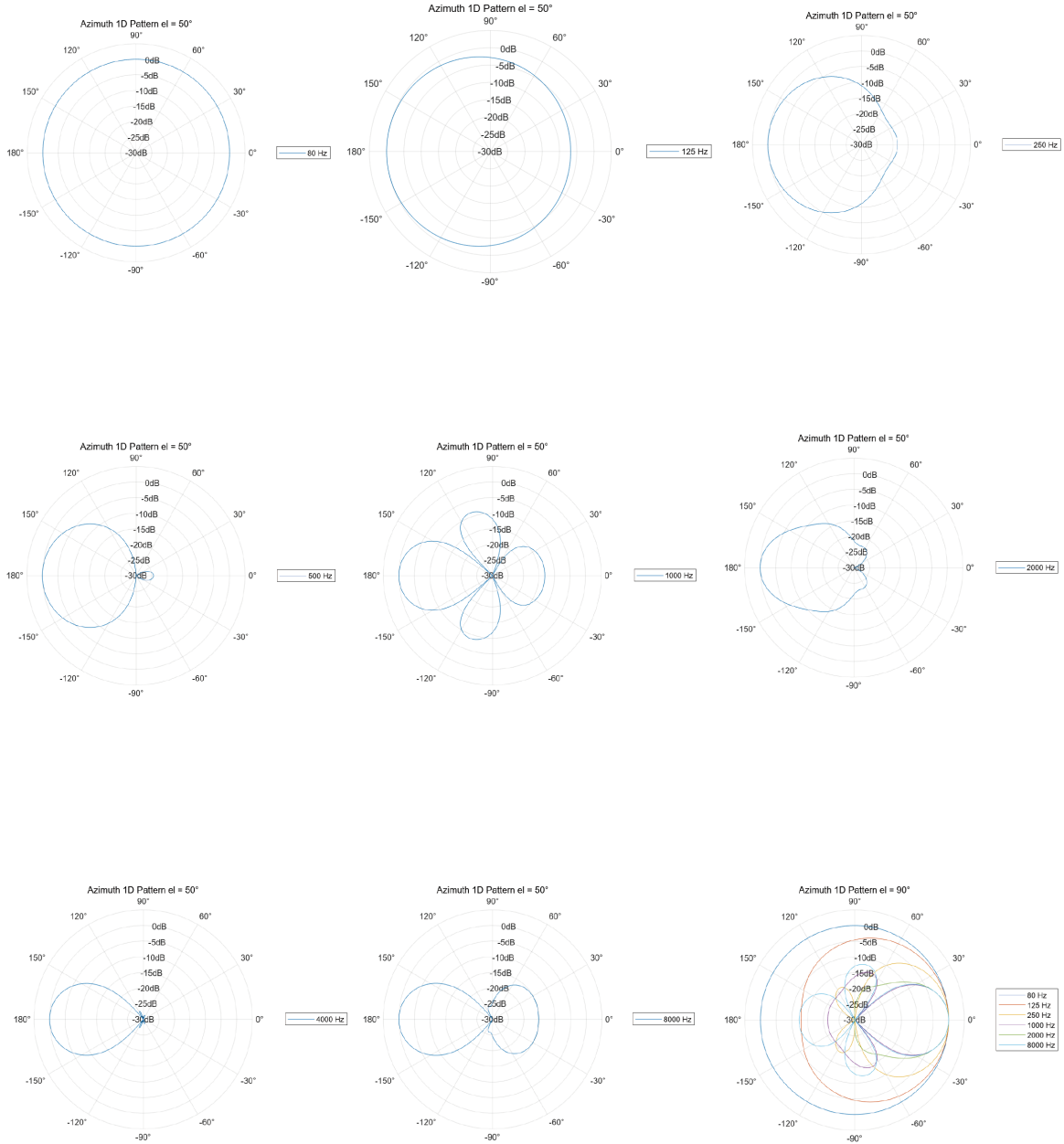

Dimensions

Unit: mm

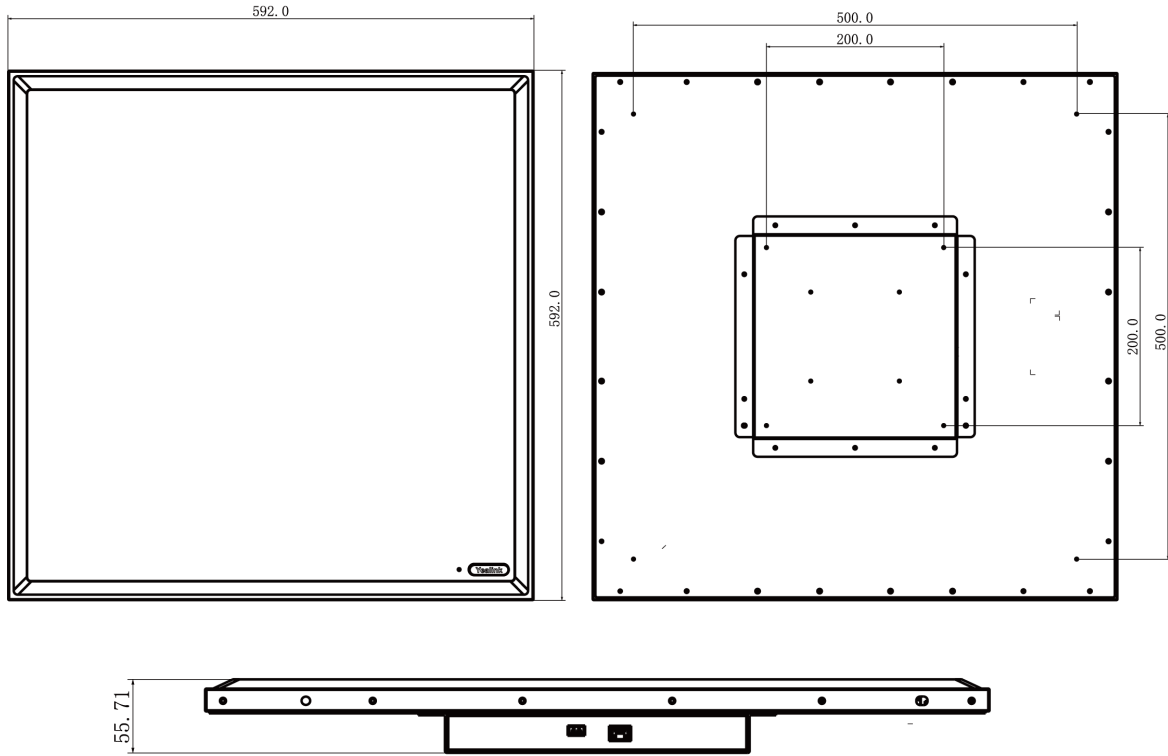

Interface



Ethernet	RJ-45 PoE+ Dante interface used for audio transmission and
----------	--

	network control
Analog Out	3-pin Phoenix connectors for analog audio output

Accessory Dimensions

Unit: mm

Angle Bracket

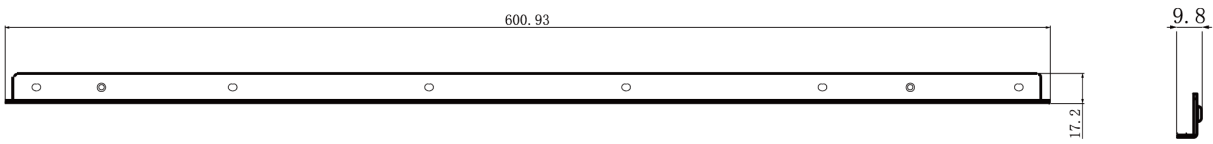

Mounting Bracket A

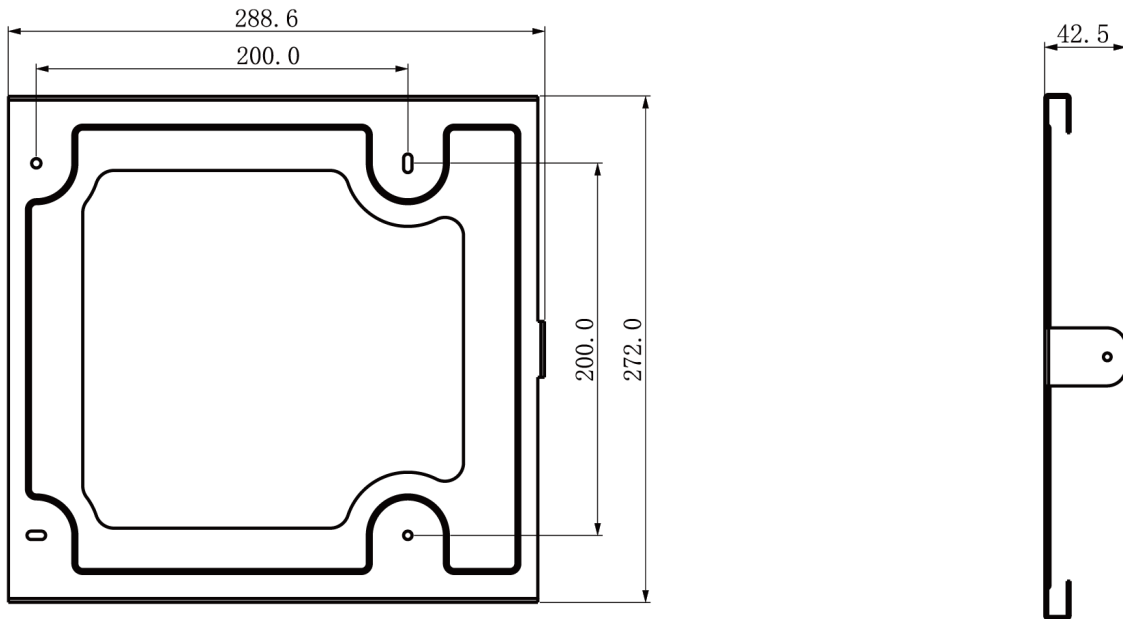

Mounting Bracket B

